

Schematic Diagram

MULTIMODE II



VFO-input.

Lockout

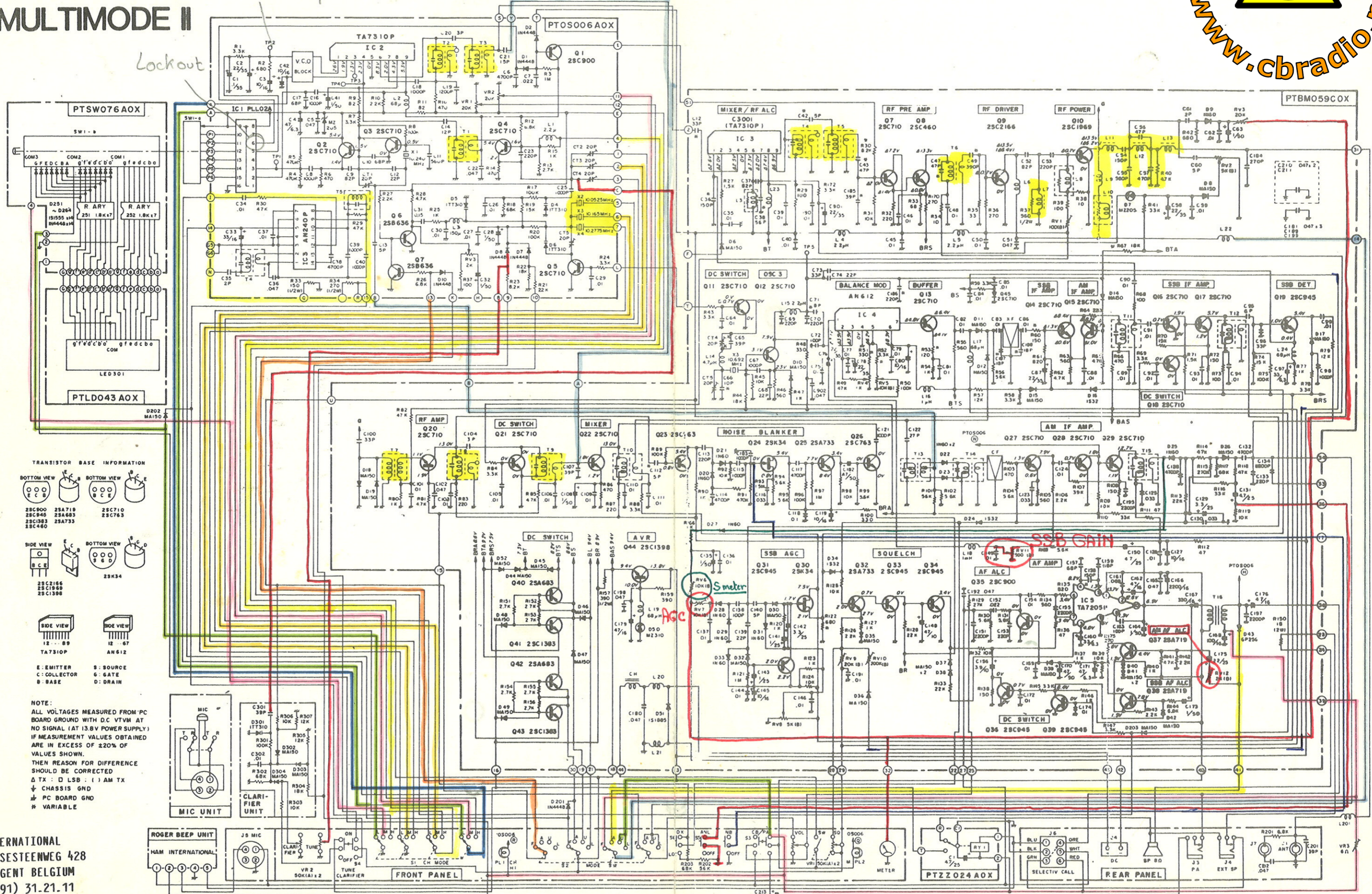

TRANSISTOR BASE INFORMATION

BOTTOM VIEW	BOTTOM VIEW	BOTTOM VIEW	BOTTOM VIEW
28C900	25A719	25C710	28C460
28C945	25A683	28C763	
28C183	25A733		
28C460			

SIDE VIEW	BOTTOM VIEW	BOTTOM VIEW
25C2166	29K34	29K34
25C1969		
25C1398		

SIDE VIEW	SIDE VIEW
TA7310P	AN612
E: EMITTER	S: SOURCE
C: COLLECTOR	G: GATE
B: BASE	D: DRAIN

NOTE:
ALL VOLTAGES MEASURED FROM PC BOARD GROUND WITH D.C. VTVM AT NO SIGNAL (AT 13.8V POWER SUPPLY). IF MEASUREMENT VALUES OBTAINED ARE IN EXCESS OF ±20% OF VALUES SHOWN, THEN REASON FOR DIFFERENCE SHOULD BE CORRECTED.
Δ TX : D LSB : () AM TX
↓ CHASSIS GND
⊥ PC BOARD GND
* VARIABLE

HAM INTERNATIONAL
BRUSSELESTEENWEG 428
B 9218 GENT BELGIUM
TEL. (091) 31.21.11
TLX. 12521 HAM B

043A0X

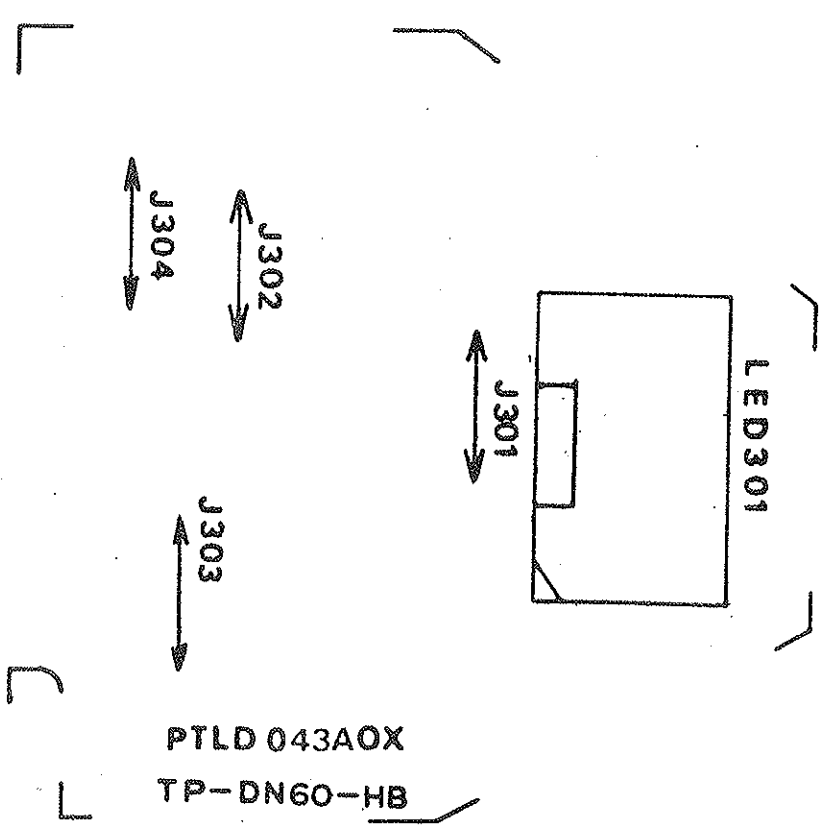

三和、材質 100E 記入。専

CHANNEL LED

PLD043A0X
三和

5.53.4.13. 201.
三和工業

PTLD043A0X
109-107

寸法図は PTLD02300X
と同様(材質変更)

SEI 仕様 1/24/

非ハット工業

043A0X11

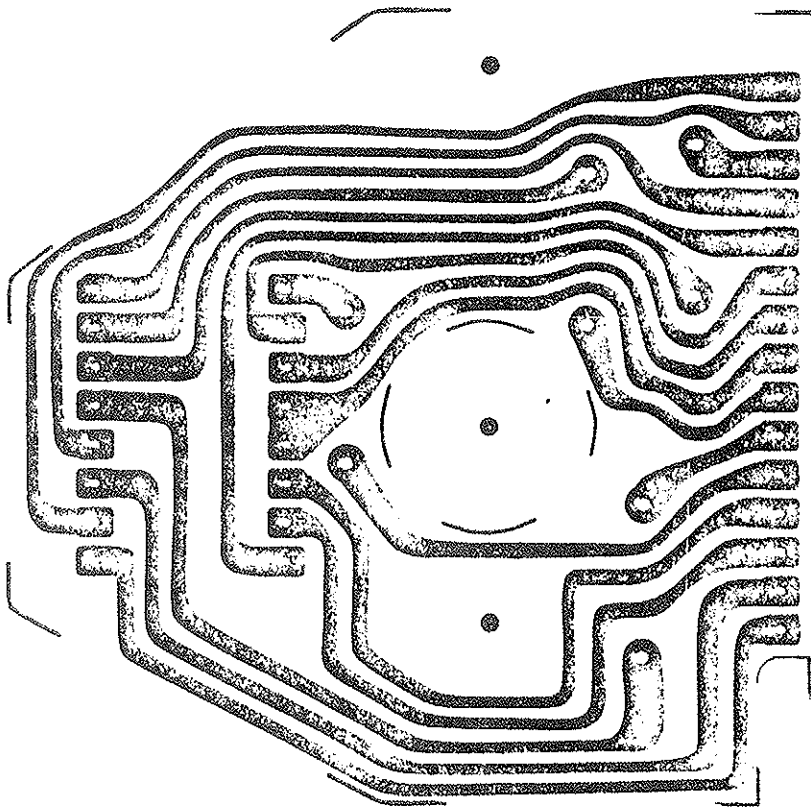

10) 材質 10) 6 記入の事

H)

▽ 1.23 x 1.7

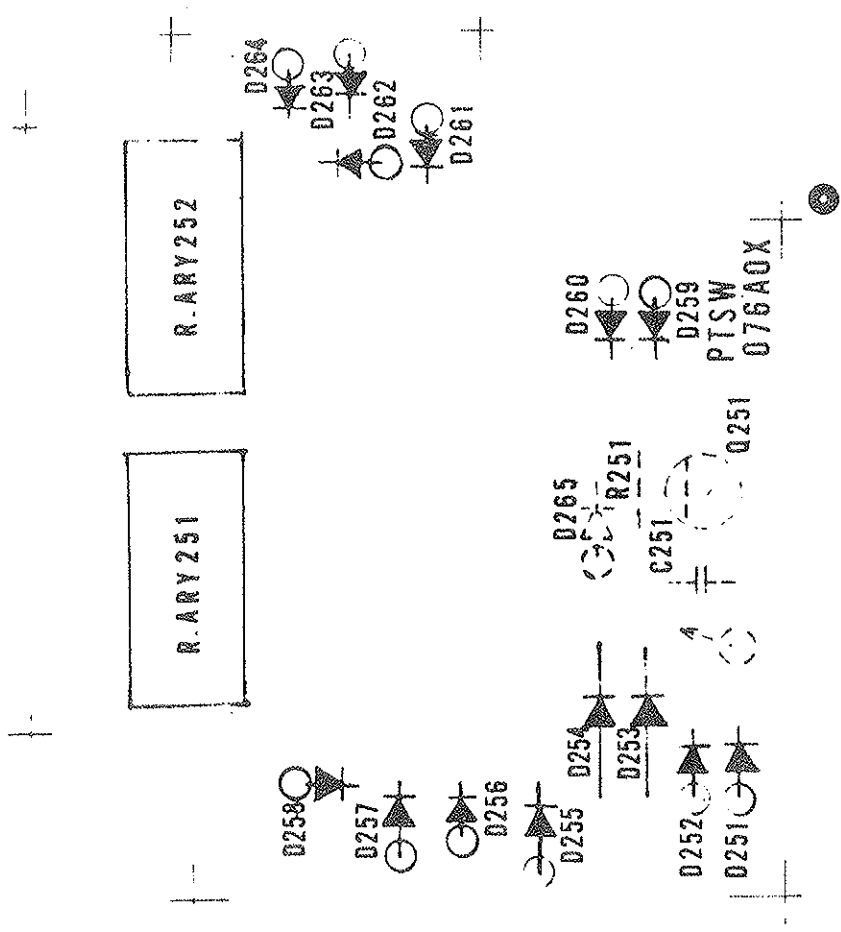

CHANNEL
SELECTOR

PTSN 076A0X
シロノ 図

サイバネット二葉
第一設計 千葉

118 頁

118 頁

118 頁

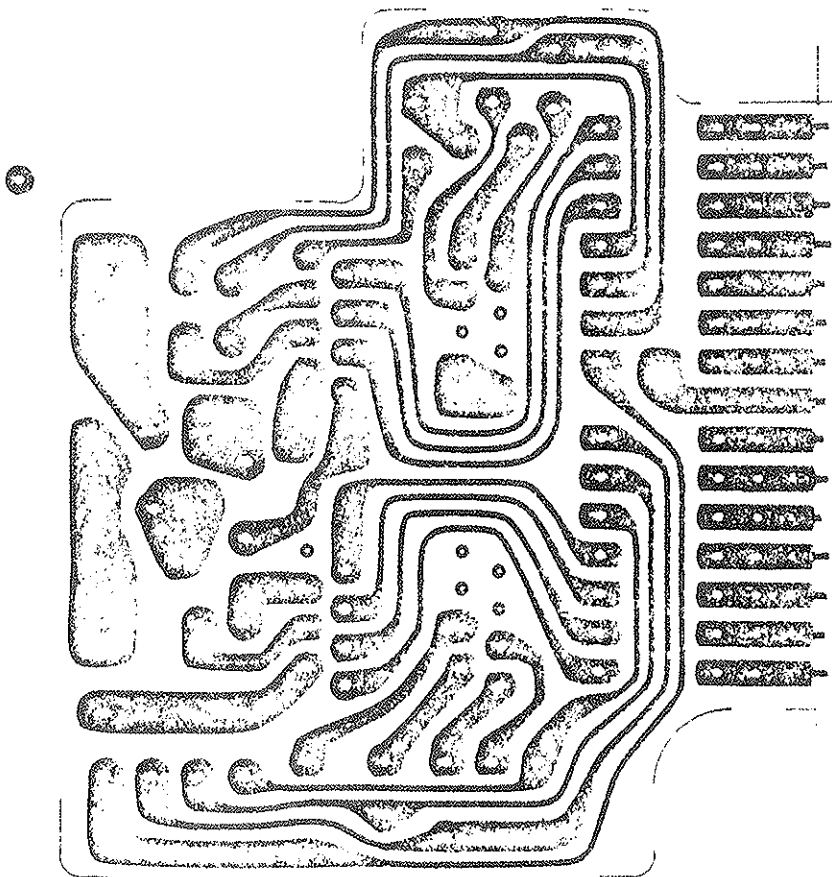

112 upc

●
 注意!! 反射あり (注意!!)

XP 5540

PTZZ024A0X

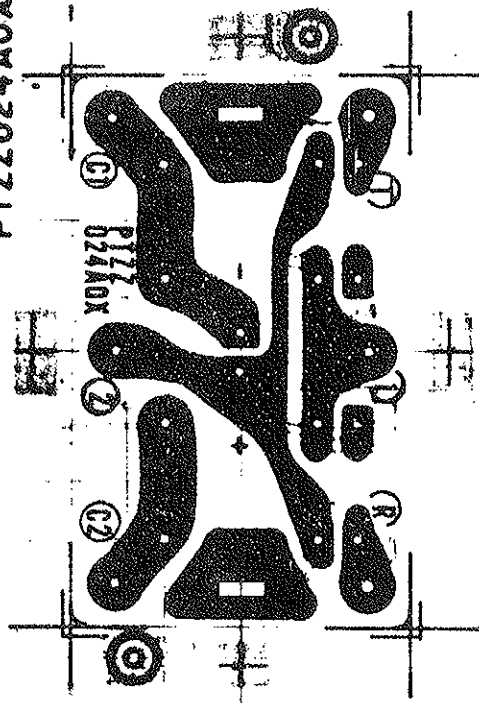

继电器

RELAY PCB

PT05006A0X

PLLXLS

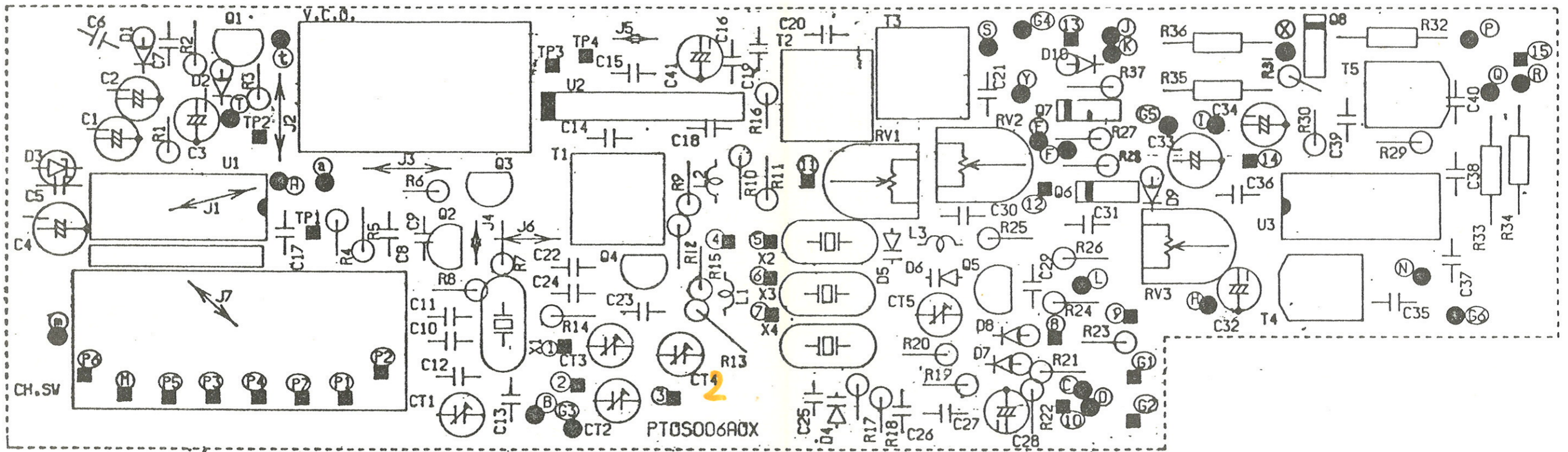

SYNTHESIZER
PCB

(K)

177

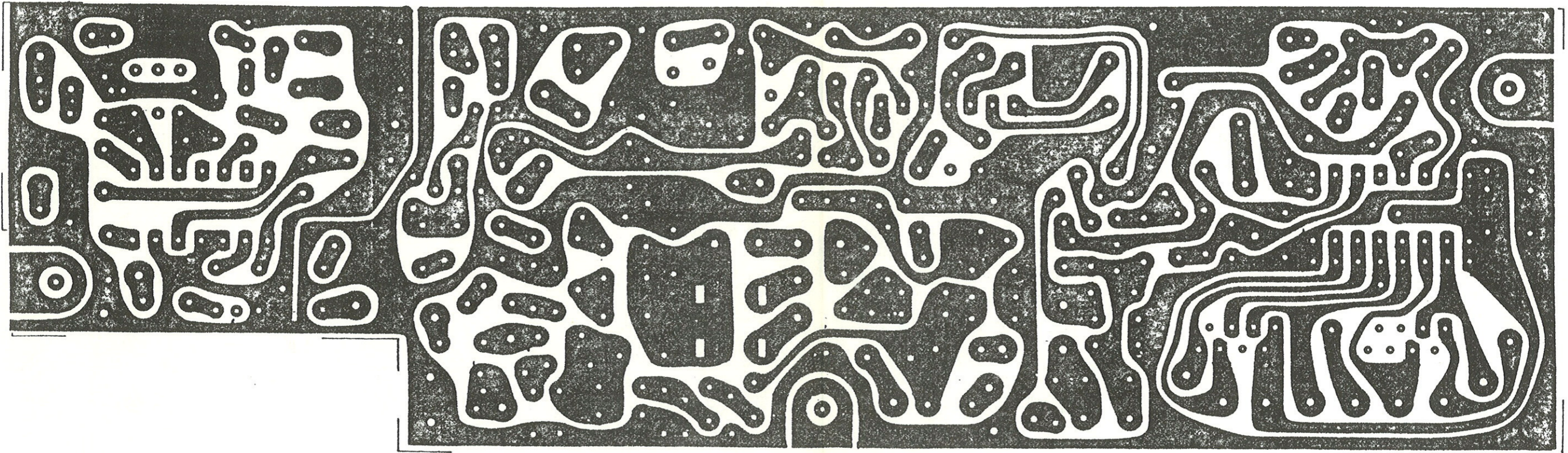

51X177 A24t
51

PTOS006A0X (パーツ図)

サカイネット工業 K.K.

(表)

銅ハツ面

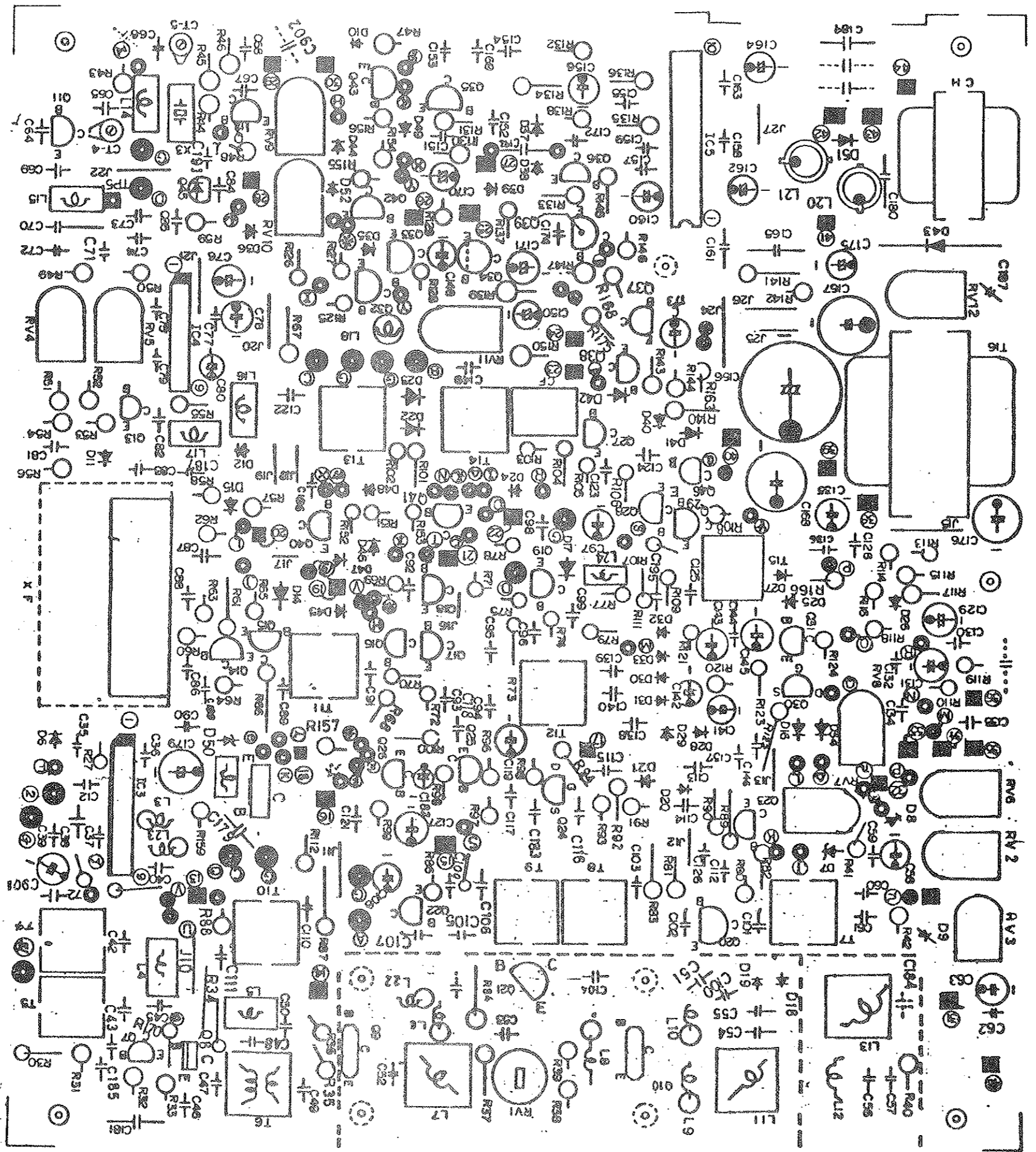

P76M054 cor

MAIN PCB
(PTBM059)

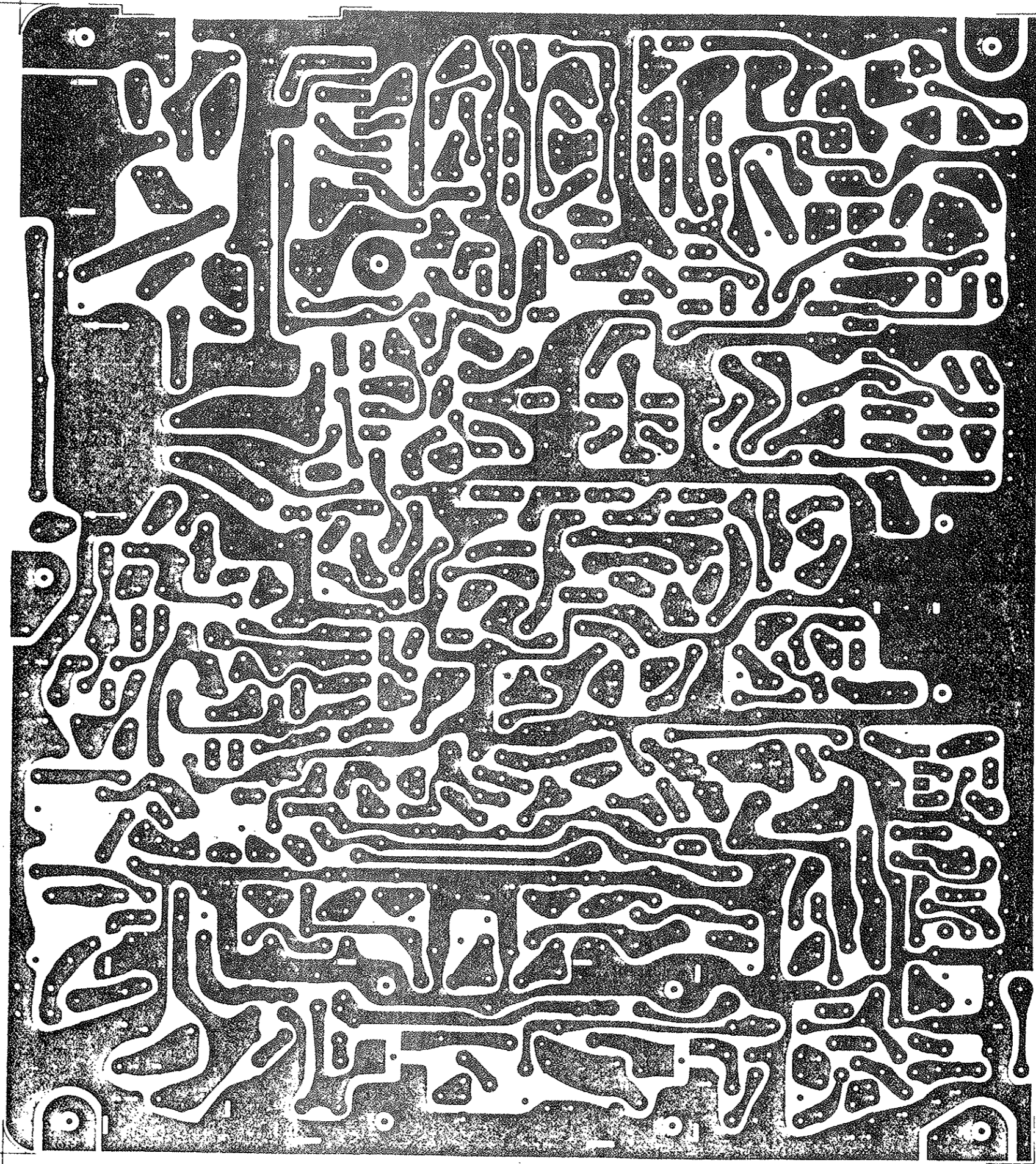

PTBM059C0X

2/1 1985

PTBM059C0X

サハハネ工業(株)

有設計 出田